



 **TELTONIKA**



LEGAL NOTICE

Copyright © 2010 TELTONIKA Ltd. All rights reserved. Reproduction, transfer, distribution or storage of part or all of the contents in this document in any form without the prior written permission of TELTONIKA Ltd is prohibited.

Other product and company names mentioned herein may be trademarks or trade names of their respective owners.

ATTENTION



Before using the device we strongly recommend to read this user manual.



Do not rip the device. Do not touch the device if the device is broken or its connecting wires are without isolation.



All wireless devices for data transferring may be susceptible to interference, which could affect performance.



The device is not water-resistant. Keep it dry.



The device requires high 230V AC voltage.

IMPORTANT NOTES!

It is mandatory to read the notes and manual carefully before starting to use the device.

Table of contents

SAFETY INFORMATION	4
GETTING STARTED.....	5
PHONE OVERVIEW	9
1.1 Description of the phone	9
1.2 LCD screen icons	9
1.3 DPH401 menu structure	10
CALL FUNCTIONS	11
1.4 Making calls.....	11
1.5 Receiving calls.....	11
1.6 Ending calls	11
SMS	12
1.7 Read SMS	12
1.8 Send SMS	12
1.9 Delete SMS	12
1.10 Message Settings.....	13
ADDITIONAL FEATURES	13
1.11 Date and Time Settings.....	13
1.12 Address Book.....	14
1.13 Speed Dialing.....	14
1.14 Audio Settings	14
1.15 Alarm.....	15
1.16 Language Selection.....	16
1.17 Dial delay	16
1.18 Baby call	16
1.19 Operator selection.....	17
1.20 Security settings.....	17
1.21 Restore Factory Defaults.....	18
SUPPLEMENTARY SERVICES (NETWORK DEPENDENT).....	18
1.22 Call Barring	18
1.23 Call Waiting.....	19
1.24 Call Transfer.....	19
1.25 Call Conference	19
1.26 Hide Call number	20
TECHNICAL SPECIFICATIONS.....	21
TROUBLESHOOTING	22

SAFETY INFORMATION

In this document you will be instructed how to use GSM Desktop Phone safely. We suggest you to adhere to following recommendations to avoid any damage to person or property. You have to be familiar with the safety requirements before starting to use the device!



Device requires power supply source that satisfies all safety requirements listed in LST EN 60950-1 standard. Each power supply source should not exceed 15VA.



Socket RJ45 is used for device firmware upgrade. Only qualified personnel with proper equipment can upgrade the device.



Do not mount or serve device during a thunderbolt.

To disconnect power for the device please do the following:

- Plug off AC/DC power adapter from the wall outlet.
- Turn off using power on/off button.

To avoid mechanical damage of the device it is recommended to transport the device packed in damage-proof pack. Protection against over currents, short circuits and earth faults should be provided as a part of the building installation. Additional two pole protective device is required to protect from short-circuit and earth fault. The power of connected device should satisfy power of release device. The creepage distance between contacts should be no less than 3mm. While using the device, it should be placed so, that it would be possible to plug off AC/DC power adapter from the wall outlet.

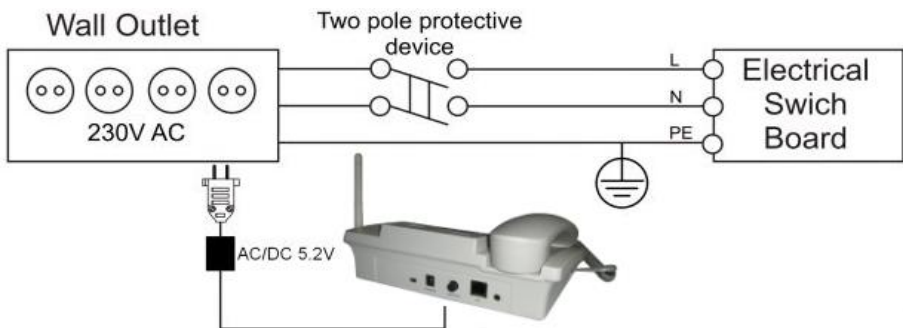

Signal level of the device depends on the environment in which it is working. If the device starts working insufficiently only qualified personnel may repair this product. We recommend to send it to repair centre or to manufacturers. There are no exchangeable parts inside of the device.

GETTING STARTED

Package Contents

- A. Handset with cable
- B. Phone device
- C. Battery
- D. Power supply adapter
- E. External GSM Antenna
- F. USB Cable



Note: If any of the components are missing or damaged, please contact the retailer or reseller from which this product was purchased.

Inserting SIM card

Note: SIM card is mandatory for setting up connection to the GSM network. If you don't have a SIM card please contact your network service provider.

1. Unplug the power supply adapter
2. Open cover



3. Flip SIM card holder and gently insert SIM card in the slot



4. Close SIM card holder

Connect back up battery

Battery is under the same cover as the SIM card. To install the battery plug the battery connector in to the battery socket.



Connect handset

Connect one handset cable end to the handset and another one to the phone jack.



Attach antenna

Screw the antenna in a clockwise direction.



Position the antenna upwards at its connecting joint. This will ensure optimal reception.

Wall mounting

GSM desktop phone can be mounted on the wall. Device has two holes for mounting as shown in figure below:

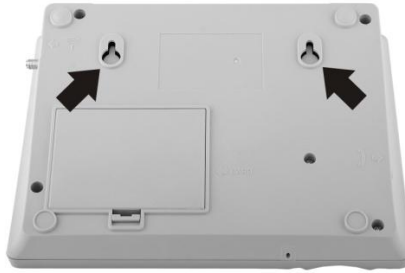

To mount device on the wall please do the following:

1. Mark a location for two holes 115mm horizontally apart and drill two holes in the wall.
2. Install the screws (not supplied) into the wall, leaving a gap of approximately 3 mm between screw head and wall.
3. Mount the GSM desktop phone on screws.

Turning on GSM desktop phone

Before turning on the phone make sure that:

- SIM card is inserted
- Battery is connected (not necessary)
- Antenna is attached
- Handset is connected to the phone
- Power adapter is connected

After all these operations are done you can switch the phone on by pushing the power button on a back panel. After the device is switched on it will start up. LCD screen will display information that the phone is starting up. To turn off the phone press the same button again.

Connecting Handsfree earphones to GSM desktop phone

Plug in 3.5 mm earphone jack to device.



Earphones are used instead of internal deskphone handsfree speaker and microphone.

Connecting GSM desktop phone to personal computer

GSM desktop phone can be connected to PC for internet connection.

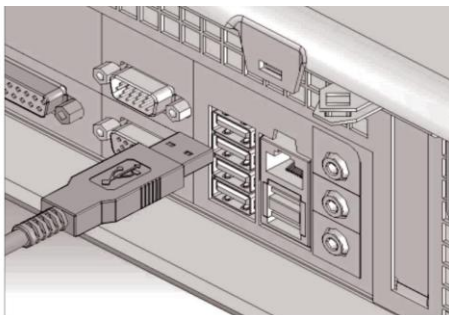

Power device on and wait until start up completes. Operator name on device LCD will indicate that start up is complete. Plug USB cable into PC and GSM desktop phone. Installation should start automatically within few seconds. If installation does not start automatically, go to My Computer and after several seconds you should see the drive named  Teltonika Deskphone (J:)

If drive has not appeared unplug and plug USB cable. If this does not help restart your PC. Double click on the drive icon that appeared to start installation.

PHONE OVERVIEW

1.1 Description of the phone



1.2 LCD screen icons

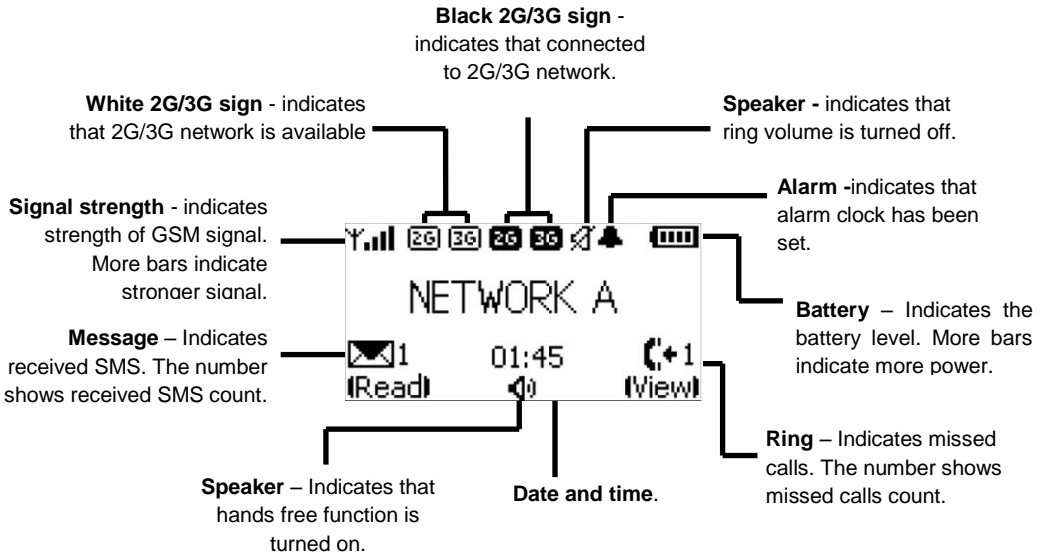

1.3 DPH401 menu structure

User friendly menu navigation allows reaching all GSM Desktop phone features.

Menu navigation

To enter menu press the functional **MENU** key.

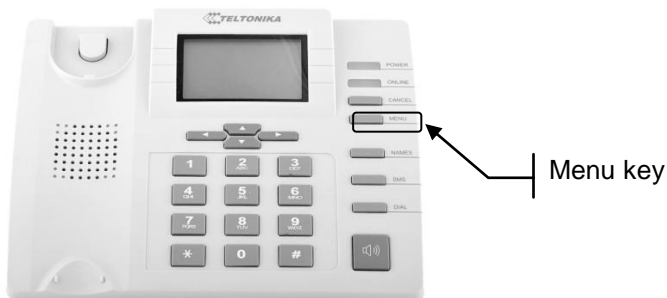

Menu items are selected by using up and down arrow keys ▲▼ located below the LCD screen.

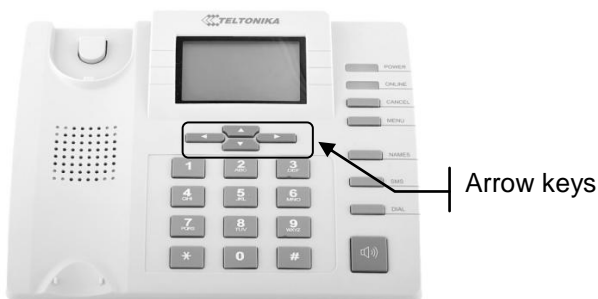

To enter selected menu function press left arrow key ◀ (LCD displays **OK**), to exit press right arrow key ▶ (LCD displays **Exit**).

Menu structure is shown below

Messages:

Create message
Inbox
Clear inbox
Message settings

Call register:

Missed calls
Received calls
Dialed numbers
Clear lists

Contacts:

Phone book
Speed dial
New contact

Settings:

Language
Sound
Call services
Time and date
Security
Operator selection
Misc
Factory reset

CALL FUNCTIONS

1.4 Making calls

- Pick up the handset or press the speaker phone key
- Wait for dial tone
- Enter the phone number then press **DIAL** key or wait for 5s or use a **Phone book** to select contact and press **Call**.

Note: To input the “+” character press and hold “0” key.

Correct entered number

- To delete one character press the **Delete** key once
- To delete all character press the **Delete** key until all digits are cleared

Redial last entered number

- Press the **DIAL** key
- Use arrow keys ▲▼ to select a number
- Pick up the handset

1.5 Receiving calls

Answering call

To answer the call, pick up the handset or press the speaker phone key

Reject call

To reject call press **Disconn.**

Note: incoming call number is displayed on the LCD. The caller ID and call number is displayed on the LCD if the number is stored in the phone book.

Note: If there are missed calls the icon “Ring” on the LCD screen is displayed. Number near the icon shows how many calls where missed.

1.6 Ending calls

To end a call place the handset back onto the cradle or press the speakerphone key if using the hands free feature.

SMS

GSM Desktop phone allows sending and receiving SMS text messages. Each SMS message can be up to 160 characters length. Contact your service provider to activate SMS service.

1.7 Read SMS

Read received message

When a new message is received icon "Message" on the LCD screen is displayed. To read the message press **Read**.

Read message from inbox

- Press the **MENU** key
- Select **Messages** and press **OK**
- Select **Inbox** and press **OK**
- Select message from the list by using arrow keys ▲▼ and press **Read**

Reply to received Messages

- View the desired message
- Press **Options** and press **OK**
- Select **Reply** and press **OK**
- Type the text using number keypad and press **Send**
- Press **Send** again

Forward text Message

- View the desired message
- Press **Options** and press **OK**
- Select **Forward** and press **OK**
- Enter the phone number or use **Phone book** to select an contact
- Press **Send**

1.8 Send SMS

- Press **SMS** key
- Type the text using number keypad and press **Send**
- Enter the phone number or use a **Phone book** to select contact
- Press **Send**

1.9 Delete SMS

- Press the **MENU** key
- Select **Messages** and press **OK**
- Select **Inbox** and press **OK**
- Select message from the list and press **Read**
- Press **Options** select **Delete** and press **OK**

1.10 Message Settings

Message Center

- Press the **MENU** key
- Select **Messages** and press **OK**
- Select **Message settings** and press **OK**
- Select **Service center** by and press **OK**
- Enter the number that your service provider gave you and press **OK**

*Note: If the number is already entered, press **OK**.*

Message Lifetime

- Press the **MENU** key
- Select **Messages** and press **OK**
- Select **Message settings** and press **OK**
- Select **Validity period** and press **OK**
- Using arrow keys ▲▼ select preferred message lifetime and press **OK**

Note: Message lifetime is the amount of time that an unread message will remain on the network server before being removed.

ADDITIONAL FEATURES

1.11 Date and Time Settings

Set the time

- Press the **MENU** key
- Select **Settings** and press **OK**
- Select **Time and date** and press **OK**
- Select **Adjust time** and press **OK**
- Set time by using number keypad or arrow keys ▲▼ and press **OK**

Change the time format

- Press the **MENU** key
- Select **Settings** and press **OK**
- Select **Time and date** and press **OK**
- Select **Time format**, select preferred time format and press **OK**

Set the date

- Press the **MENU** key
- Select **Settings** and press **OK**
- Select **Time and date** and press **OK**
- Select **Adjust date** and press **OK**
- Set date by using number keypad or arrow keys ▲▼ and press **OK**

Change the date format

- Press the **MENU** key
- Select **Settings** and press **OK**
- Select **Time and date** and press **OK**
- Select **Date settings** and press **OK**
- Select **Date format**, select date format by using arrow keys ▲▼ and press **OK**

Turn date display on the LCD screen On/Off

- Press the **MENU** key
- Select **Settings** and press **OK**
- Select **Time and date** and press **OK**
- Select **Date settings** and press **OK**
- Select **Show date**, select **ON** or **Off** and press **OK**

1.12 Address Book

GSM desktop phone stores all contacts in the SIM card. Depending on the SIM card (SIM cards may have different memory capacities) phonebook is capable of storing up to 240 phone numbers with names.

*Note: To dial a number from the phonebook pick up the handset and press **Phone book**.*

Add new contact

- Press the **MENU** key
- Select **Contacts** and press **OK**
- Select **New contact** and press **OK**
- Enter name the by using number keypad and press **OK**
- Enter the number by using number keypad and press **OK**

Note: To input the “+” character press and hold “0” key.

Edit contact in the phone book

- Press the **NAMES** key
- Select contact by using arrow keys ▲▼
- Press **Options**, then select **Edit contact** and press **OK**
- Edit the name and press **OK** then edit the number and press **OK**

Delete contact

- Press the **NAMES** key
- Select contact by using arrow keys ▲▼
- Press **Options**, then select **Delete** by and press **OK**

1.13 Speed Dialing

Speed dialing function allows to quickly selecting saved number by using a number keypad keys (1-9). To program number keypad keys please do the following:

- Press the **MENU** key
- Select **Contacts** and press **OK**
- Select **Speed dial** and press **OK**
- Select wanted keypad number and press **Options**
- Select **Edit number** press **OK**
- Enter the number and press **OK**

1.14 Audio Settings**Increase/Decrease ring volume**

- Press the **MENU** key

- Select **Settings** and press **OK**
- Select **Sound** and press **OK**
- Select **Ring volume** and press **OK**
- Change ring volume by using arrow keys ▲▼ and press **OK**

Change ring tone

- Press the **MENU** key
- Select **Settings** and press **OK**
- Select **Sound** and press **OK**
- Select **Ring tone** and press **OK**
- Select preferred ring tone by using arrow keys ▲▼ and press **OK**

Increase/Decrease message volume

- Press the **MENU** key
- Select **Settings** and press **OK**
- Select **Sound** and press **OK**
- Select **Message volume** and press **OK**
- Change message volume by using arrow keys ▲▼ and press **OK**

Select message tone

- Press the **MENU** key
- Select **Settings** and press **OK**
- Select **Sound** and press **OK**
- Select **Message tone** and press **OK**
- Select preferred melody tone by using arrow keys ▲▼ and press **OK**

Increase/Decrease speech volume

- Press the **MENU** key
- Select **Settings** and press **OK**
- Select **Sound** and press **OK**
- Select **Speech volume** and press **OK**
- Change speech volume using arrow keys ▲▼ and press **OK**

Turn On/Off phone keypad tone

- Press the **MENU** key
- Select **Settings** and press **OK**
- Select **Sound** and press **OK**
- Select **Key tone** and press **OK**
- Using arrow keys ▲▼ select *On* or *Off* and press **OK**

1.15 Alarm

The alarm feature can be used as an alarm clock. Alarm time and tone can be set for daily use or for one time only.

Set alarm time

- Press the **MENU** key
- Select **Settings** and press **OK**
- Select **Time and date** and press **OK**
- Select **Alarm** and press **OK**
- Select **Alarm time** and press **OK**, then select *On* and press **OK**
- Set time using number keypad or by using arrow keys ▲▼ and press **OK**

- Choose repeat alarm or not (**On** or **Off**) and press **OK**
- If repeat- select days to by repeat alarm using arrow keys ▲▼ and pressing **Change**. When finished press **OK**.

Set alarm volume

- Press the **MENU** key
- Select **Settings** and press **OK**
- Select **Time and date** and press **OK**
- Select **Alarm** and press **OK**
- Select **Alarm options** and press **OK**
- Select **Alarm volume** and press **OK**
- Change alarm volume by using arrow keys ▲▼ and press **OK**

Set alarm tone

- Press the **MENU** key
- Select **Settings** and press **OK**
- Select **Time and date** and press **OK**
- Select **Alarm** and press **OK**
- Select **Alarm options** and press **OK**
- Select **Alarm tone** and press **OK**
- Select preferred alarm melody by using arrow keys ▲▼ and press **OK**

1.16 Language Selection

To select the language use following instructions:

- Press the **MENU** key
- Select **Settings** and press **OK**
- Select **Language** and press **OK**
- Select preferred language by using arrow keys ▲▼ and press **OK**

1.17 Dial delay

Dial delay is the amount of time, for the phone before automatically making a call after dial number is entered. To set the time use following instructions:

- Press the **MENU** key
- Select **Settings** and press **OK**
- Select **Call services** and press **OK**
- Select **Dial delay** and press **OK**
- Select delay time by using arrow keys ▲▼ and press **OK**

1.18 Baby call

Baby call feature allows automatic calling after handset is picked up. The time and number are programmed. Use following instructions to enable this feature:

- Press the **MENU** key
- Select **Settings** and press **OK**
- Select **Call services** and press **OK**
- Select **Baby call** and press **OK**
- Select **Baby call delay** and press **OK**
- Select delay time and press **OK**
- Select **Baby call number** and press **OK**

- Enter the phone number or use a **Phone book** to select contact

*Note: to disable Baby call feature select **Disable** in **Baby call delay** menu.*

1.19 Operator selection

Desktop Phone allows selecting operator using automatically or manually. Select Automatic to set the device to automatically select one of the cellular networks available in your area. With manually selected network, the phone will connect only to the manually set operator network.

Manual operator selection

- Press the **MENU** key
- Select **Settings** and press **OK**
- Select **Operator selection** and press **OK**
- Select **Manual** and press **OK**. The phone will search for available networks.
- Select preferred network from the given list and press **OK**

Note: manual you can select a network preferred that has a roaming agreement with your service provider when the phone is used abroad.

1.20 Security settings

Change PIN code

- Press the **MENU** key
- Select **Settings** and press **OK**
- Select **Security** and press **OK**
- Select **Change PIN code** and press **OK**
- Enter PIN code and press **OK**
- Enter new PIN code and press **OK**

Note: to change PIN code PIN code request must be enabled.

Pin code request

- Press the **MENU** key
- Select **Settings** and press **OK**
- Select **Security** and press **OK**
- Select **PIN code request** and press **OK**
- Enter PIN code and press **OK**
- Select **Enable PIN request** or **Disable PIN request** and press **OK**

Show IMEI number

- Press the **MENU** key
- Select **Settings** and press **OK**
- Select **Misc** and press **OK**
- Select **Show IMEI** and press **OK**

Show software version

- Press the **MENU** key
- Select **Settings** and press **OK**
- Select **Misc** and press **OK**
- Select **Show software version** and press **OK**

1.21 Restore Factory Defaults

- Press the **MENU** key
- Select **Settings** and press **OK**
- Select **Factory reset** and press **OK**
- Confirm resetting device to factory defaults by pressing **OK**

SUPPLEMENTARY SERVICES (NETWORK DEPENDENT)

1.22 Call Barring

Call barring feature allows barring of incoming or outgoing calls. The following calls barring options are available:

All outgoing - do not allow any calls to be made.

Outgoing international - do not allow international calls.

Int. ex. to home country - do not allow international calls except to home country.

All incoming - do not allow any incoming calls.

Incoming when roaming - do not allow any incoming calls if roaming

Disable all - do not allow any calls to be made or received.

Turn On/Off call barring feature

- Press the **MENU** key
- Select **Settings** and press **OK**
- Select **Call services** and press **OK**
- Select **Call barring** and press **OK**
- Select the desired barring type
- Using arrow keys ▲ ▼ select **Enable/Disable** and press **OK**

1.23 Call Waiting

Call Waiting enables notification of incoming calls when the DPH401 is on call. To respond to Call Waiting, press **Answer** to answer or **Reject** to reject the call. Press **Options** then **Hold** to switch between incoming calls. Contact your service provider to activate Call Waiting feature.

Turn On/Off call waiting feature

- Press the **MENU** key
- Select **Settings** and press **OK**
- Select **Call services** and press **OK**
- Select **Call waiting** and press **OK**
- Using arrow keys ▲▼ select **Enable/Disable** and press **OK**

1.24 Call Transfer

A call transfer feature allows transferring an existing call to another phone. Contact your service provider to activate Call Transfer feature.

Call transfer

- During call press **Hold**,
- Press **Options**, then select **New call** and press **OK**
- Enter the phone number and press **DIAL** key or use a **Phone book** to select contact and press **Call**.
- Press **Options**, select **Transfer** and press **OK**

Note: to use a speed dialing press and hold the key for 2s.

*Note: to switch between calling numbers press **Options** then press **Hold**.*

1.25 Call Conference

To start conference calls make a new call or answer to incoming call. Put the conference call on hold (press **Options** then **Hold**) and add new participants.

Add new participant

- During call press **Hold**,
- Press **Options**, then select **New call** and press **OK**
- Enter the phone number and press **DIAL** key or use a **Phone book** to select contact and press **Call**.
- Press **Options**, select **Join calls** and press **OK**

Release a participant

- During call press **Options**
- Select **Conference list** and press **OK**
- From the conference participants list select the one which should be release and press **Release**

1.26 Hide Call number

Using this network service feature allow to set whether your phone number is shown or hidden to the person you are calling to.

Turn On/Off hide number feature

- Press the **MENU** key
- Select **Settings** and press **OK**
- Select **Call services** and press **OK**
- Select **Hide number** and press **OK**
- Using arrow keys ▲ ▼ select **Enable/Disable** and press **OK**

TECHNICAL SPECIFICATIONS

GSM Interface

Quad-Band 850/900/1800/1900MHz

3G data Interface

UMTS single, dual or tri band (2100/1900/900/850)

HSUPA

Download: 7,2 Mbps

Upload: 5,76 Mbps

Memory

Address book up to 240 entries (SIM dependent)

SMS memory up to 30 (SIM dependent)

Call memory: 10 last dialed, 10 last received, 10 last missed

Power supply

Mains adaptor: 100 - 240 V AC / 5.2V $\overline{\text{---}}$ 1A

Built in lightning protection

Battery: NiMH 3.6V 1200 mAh

Power consumption when talking 3W (peak)

Battery charging time 20 hours

Talking time: 60 minutes

Temperature & humidity

Operation 0⁰ to 55⁰ C

Storage temperature -20⁰ to 80⁰ C

Humidity 10% to 90%

Storage humidity 5% to 95%

Dimensions / weight

Approx. 220 x 170 x 65 mm

Weight: Approx. 920 g

Other

External omni directional antenna (SMA)

Antenna Gain 2dBi

Port for FW update - RJ45 (UART)

3,5 mm jack for Headset Connection

mini B USB connector for 3G internet

Zero CD (Easy Installation)

TROUBLESHOOTING

Messages	Description	Solution
No network	1. Antenna not connected 2. No network signal or signal level too low	1. Connect antenna and wait until network is found 2. Contact your GSM network operator
Error	General error message	Contact your GSM network operator if message persists
Network timeout	Request failed to execute	Contact your GSM network operator if message persists
Error sending	Error occurred while sending SMS	1. Check Service center number under Message settings. 2. Contact your GSM network operator
Wrong format	Format of received SMS is not supported	
SIM not inserted	SIM card is not inserted	Turn device Off, insert SIM card and turn device On
SIM failure	SIM card is corrupted or missing	Turn device Off, insert valid SIM card and turn device On
SIM busy	SIM card is busy	1. Wait for SIM card to become available 2. Insert valid SIM card 3. Contact your GSM network operator
SIM wrong	Wrong SIM card is inserted	Turn device Off, insert valid SIM card and turn device On
Enter PIN	PIN code is required	1. Enter correct PIN code 2. Contact your GSM network operator
Enter PIN2	PIN2 code is required	1. Enter correct PIN2 code 2. Contact your GSM network operator
Enter PUK	PUK code is required	1. Enter correct PUK code 2. Contact your GSM network operator
Enter PUK2	PUK2 code is required	1. Enter correct PUK2 code 2. Contact your GSM network operator
Service not available	Service requested is not available	Contact your GSM network operator for available services
Service not subscribed	Service requested is not subscribed	Contact your GSM network operator for available services
Service code error	Error occurred while executing service request	Contact your GSM network operator for available services
Phone book error	Error occurred during initialization of Phone book	Replace SIM card if error persists
Inbox error	Error occurred during initialization SMS inbox	Replace SIM card if error persists
Inbox full	SMS inbox is full	Delete some/all messages to be able to receive new SMS messages